

# beko

## Full Automatic Espresso Machine with Integrated Milk Cup and TFT Touch Screen

User Manual



CEG 7348 X  
CEG 7348 B  
CEG 7348 DX

EN - TR - FR - PL - RO - CS - SK - SR - IT - UA - HR - BG - SQ - SL - BS - MK - AR



UK  
CA  
CE

01M-8914063200-1225-07  
01M-8914721200-1225-07  
01M-8914883200-1225-07  
01M-8917773200-1225-07  
01M-8917783200-1225-07

You can download the  
HomeDirect application  
for free from the Apple App Store  
or Google Play Store to access  
the recipes.



# INDEX

ENGLISH 3-43

---

TÜRKÇE 44-85

---

FRANÇAIS 86-125

---

POLISH 126-167

---

ROMÂNĂ 168-211

---

ČESKY 212-250

---

SLOVENSKÝ 251-289

---

СРПСКИ 290-328

---

ITALIANO 329-369

---

УКРАЇНСЬКА 370-411

---

HRVATSKI 412-450

---

БЪЛГАРСКИ 451-491

---

SHQIPTARE 492-530

---

SLOVENŠČINA 531-568

---

BOSANSKI 569-606

---

МАКЕДОНСКИ 607-647

---

## Please read this user manual first!

Dear Customer,

Thank you for selecting this Beko product. We hope that you get the best results from your product, which has been manufactured to a high quality with state-of-the-art technology. Please read this entire user manual and all other accompanying documents carefully before using the product and keep them as a reference for future use. If you pass on the product to someone else, please give them the user manual as well. Please take into consideration all warnings and information in the user manual.

### Explanation of symbols

The following symbols are used in the various section of this manual:



Important information or useful hints about usage.



**DANGER:** This warning for dangerous situations with regard to life and property.



**WARNING:** This warning indicates potentially dangerous situations.



**CAUTION:** This warning indicates the potential for material damage.



Materials are suitable for food contact

# 1 Important instructions for safety and environment

This section includes the safety instructions that will help provide protection against risks of personal injury and material loss. Failure to follow these instructions invalidates any warranty.

## 1.1 Danger of electric current

Danger to life due to electric current!

Contact with live wires or components could lead to serious injury or even death!

Observe the following safety precautions to avoid electric shocks:

- Do not use the product if the power cable or the appliance itself is damaged. Contact the authorised service.
- Do not open the housing of the coffee machine. There is a risk of electric shock if live connections are touched and/or the electrical and mechanical configuration is changed.
- Before cleaning the bean container, unplug the appliance from the mains socket. Danger from the coffee grinder rotating!

## 1.2 Danger of burning or scalding

Parts of the coffee machine can become very hot during operation! Dispensed drinks and escaping steam are very hot!

Observe the following safety precautions to avoid burning/scalding yourself and/or others:

- Do not touch either of the metal sleeves on both coffee spouts.
- Avoid direct contact of the skin with steam escaping the machine or hot rinsing, cleaning or descaling water.

## 1.3 Basic safety precautions

Observe the following safety precautions to ensure safe handling of the coffee machine:

# 1 Important instructions for safety and environment

- Never play with packaging material. There is a risk of suffocation. Keep all packaging materials away from children.
- Inspect the coffee machine for visible signs of damage before use. Do not use a damaged coffee machine. Contact the authorised service.
- If the connecting cable is damaged, it should only be replaced by a service agent recommended by the manufacturer in order to prevent any danger! Please contact the manufacturer or their customer service.
- Repairs to the coffee machine must only be carried out by an authorised specialist or customer service representative. Repairs by unauthorized persons can lead to considerable danger for the user. These actions will also void the warranty.
- Repairs to the coffee machine during the warranty period may only be carried out by service centres authorised by the manufacturer, otherwise the warranty will become void in the event of subsequent damage.
- Defective parts may only be replaced with original spare parts. Only original spare parts guarantee that the safety requirements are met.
- This appliance can be used by children aged from 8 years and above if they have been given supervision or instruction concerning use of the appliance in a safe way and if they understand the hazards involved. Cleaning and user maintenance shall not be made by children unless they are older than 8 and supervised. Keep the appliance and its cord out of reach of children aged less than 8 years.
- Appliances can be used by persons with reduced physical, sensory or mental capabilities or lack of experience and knowledge if they have been given supervision or instruction concerning use of the appliance in a safe way and understand the hazards involved.
- Children shall not play with the appliance
- Cleaning and user maintenance shall not be made by children without supervision.

# 1 Important instructions for safety and environment

- This appliance is intended to be used in household and similar applications such as:
  - staff kitchen areas in shops, offices and other working environments,
  - farm houses,
  - by customers in hotels, motels and other residential type environments,
  - bed and breakfast type environments.
- Protect the coffee machine against the effects of weather such as rain, frost and direct sunlight. Do not use the coffee machine outdoors.
- Never immerse the coffee machine itself, the mains cable or the mains plug in water or other liquids.
- Do not clean the coffee machine or accessories in a dishwasher.
- Do not pour any liquids other than water or place foodstuffs into the water tank.
- Do not fill the water tank beyond the maximum mark.
- Only operate the machine when the waste container, drip tray and the cup tray are fitted.
- Do not pull the cable to remove the plug from the mains socket or touch with wet hands.
- Do not hold the coffee machine by the mains cable.
- Keep the appliance and its cord out of reach of children aged 8 or under.
- The appliance can only be used to prepare coffee.
- Children should be supervised to ensure that they do not play with the appliance.
- Unplug the appliance before each clean and when the appliance is not in use.
- Place the appliance in a way that the plug is always accessible.
- Always use the appliance on a stable, flat, clean, dry and non-slip surface.

# 1 Important instructions for safety and environment

- The appliance is not an integrated coffee machine and is not designed use inside a cabinet. The coffee maker shall not be place in a cabinet while in use.
- Do not squeeze or bend the power cord and do not rub it on sharp edges in order to prevent any damage to the power cord. Keep the power cord away from hot surfaces and naked flames.
- Ensure that the mains power supply complies with the information supplied on the rating plate of the appliance.
- Use the appliance only with a grounded socket.
- Do not use the appliance with an extension cord.
- Do not touch the appliance or its plug with wet or damp hands when the appliance is plugged in.
- CAUTION: In order to avoid a hazard due to inadvertent resetting of the thermal cut-out, this appliance must not be supplied through an external switching device, such as a timer, or connected to a circuit that is regularly switched on and off by the utility.
  - Warning: avoid spillage on the connector.
  - Do not misuse the appliance to avoid potential injury.
- If the supply cord is damaged, it must be replaced by the manufacturer or its agent or similarly qualified person in order to avoid hazard.
- Cleaning: Do not use harsh, abrasive cleaners. See for the 6.1 to 6.4 detailed cleaning instructions.
- The heating element surface is subject to residual heat after use.

# 1 Important instructions for safety and environment

## 1.4 Intended use

The Beko fully automatic coffee machine is intended for use in homes and similar applications, such as in staff kitchens, shops, offices and similar areas or by customers in bed & breakfast, hotels, motels and other living accommodation. This coffee machine is not intended for commercial use. The machine is only intended for preparing coffee and heating milk and water. Any other use other than previously stated is considered as improper use.

### **Danger resulting from improper use!**

If the coffee machine is not used for its intended purpose, it may become a source of danger.



- Consequently, the coffee machine must only be used for its intended purpose.
- Follow the procedures described in this user manual.

No claims of any kind will be accepted for damage or injury resulting from the use of the coffee machine for purposes other than its intended use. The risk must have been borne solely by the machine owner.

## 1.5 Limitation of liability

All technical information, data and instructions on installation, operation and maintenance of the coffee machine contained in these operating instructions represent the current status at the time of printing and are based on the best possible knowledge gained by experience and knowhow.

No claims/demands can be inferred from the information, illustrations and explanations in this user manual.

The manufacturer assumes no liability for damage or injury resulting from failure to observe the user manual, use of the product for purposes other than the intended use, unprofessional repairs, unauthorised modifications or use of non-approved spare parts.

# 1 Important instructions for safety and environment

## 1.6 Compliance with the WEEE Directive and Disposing of the Waste Product:

This product complies with EU WEEE Directive (2012/19/EU). This product bears a classification symbol for waste electrical and electronic equipment (WEEE).

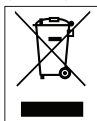

This symbol indicates that this product shall not be disposed with other household waste at the end of its service life. The used device must be returned to an official collection point for the recycling of electrical and electronic devices. To find these collection points, please contact your local authority or retailer where the product was purchased. Each household performs an important role in the restoring and recycling of old appliances. The appropriate disposal of used appliance helps prevent potential negative consequences for the environment and human health.

# 1 Important instructions for safety and environment

## 1.7 Compliance with RoHS Directive

The product you have purchased complies with EU RoHS Directive (2011/65/EU). It does not contain harmful and prohibited materials specified in the Directive.

## 1.8 Package information



The packaging materials of the product were manufactured from recyclable materials in accordance with our National Environment Regulations. Do not dispose of the packaging materials together with domestic or other waste. Take them to the packaging materials collection points designated by local authorities.

## 1.9 Plug Wiring

The moulded plug on this appliance incorporates a 13 A fuse. Should the fuse need to be replaced an ASTA approved BS1362 fuse of the same rating must be used. Do not forget to refit the fuse cover. In the event of losing the fuse cover, the plug must not to be used until a replacement fuse cover has been fitted. Colour of the replacement fuse cover must be the same colour as that visible on the pin face of the plug. Fuse covers are available from any good electrical store.

# 1 Important instructions for safety and environment

## • Fiting a different plug

- As the colours of the wires in the mains lead of this appliance may not correspond with the coloured markings identifying the terminals on your plug, proceed as follows:
- Brown cable = L (Live)
- Blue cable = N (Neutral)
- Green/yellow cable must be connected to ground (E)  $\perp$  line
- With the alternative plugs a 13 A fuse must be fitted either in the plug or adaptor or in the main fuse box. If in doubt contact a qualified electrician.

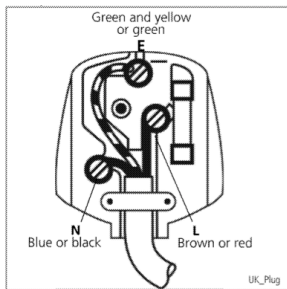

## 2 Your Fully Automatic Espresso Machine

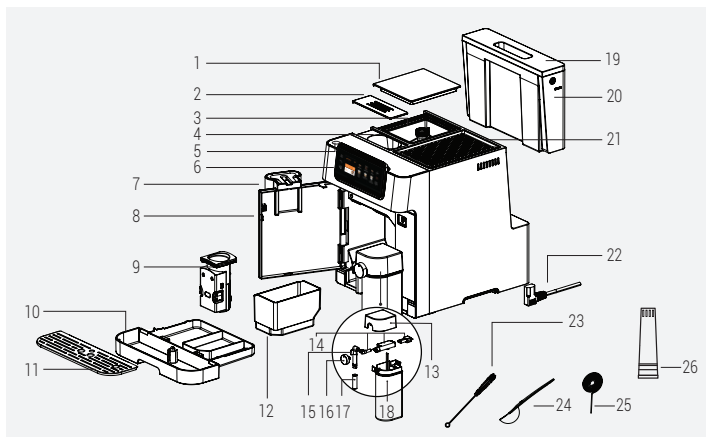











1. Coffee Bean Container Cover
2. Pre-ground Coffee Chute Cover
3. Coffee Bean Container
4. Pre-ground Coffee Chute
5. Power On/Off Button
6. Digital Control Panel
7. Adjustable Coffee Spout
8. Front Cover
9. Brewing Unit
10. Drip Tray
11. Cup Tray
12. Coffee Ground (Residual) Container
13. Milk Cup Cover
14. Milk Cup Assembly Parts
15. Milk Cup Nozzle Internal Part
16. Milk Foam Adjustment Knob
17. Milk Cup Nozzle
18. Milk Cup
19. Water Tank Cover
20. Water Tank
21. Cup Holder
22. Power Cord
23. Cleaning Brush
24. Pre-ground Coffee Spoon
25. Cleaning Needle
26. Water filter

## 2 Your Fully Automatic Espresso Machine

### Control Panel



1		Profile section
2		Used for returning to the previous screen
3		Used for switching to the Eco Mode
4		Favorites section
5		More drinks section
6		Popular beverages for fast access
7		Add extra section
8		General Error
9		Cleaning section
10		Settings

## 2 Your Fully Automatic Espresso Machine

### Technical data

#### Power supply:

220-240 V~, 50-60 Hz

#### Power: 1350 W

The right to make technical and design changes is reserved.

All declared values on the product and on the printed leaflets were obtained from laboratory measurements performed according to the relevant standards. These values may differ depending on usage and ambient conditions.

#### Conformity declaration for CE

Arçelik A.Ş. hereby declares that this appliance complies with Directive 2014/53/EU. The complete text of the EU declaration of conformity is available in the following internet address: – Products, from :beko.com The rights to make technical and design changes are reserved.

#### Product Dimensions:

27,5 cm (Width) x 35,9 cm (Height) x 41,2 cm (Depth)

**Weight:** 9.68±0.5kg

**Cable Length:** 95±5 cm

**Ground Coffee Weight (Bean Mode)**

**Soft:** 7+-2g

**Standard:** 9±2g

**Intense:** 11±2g

**Drip Tray Capacity:** Up to 0.5 L

**Coffee Ground (residual) Container Capacity:**

Up to 10 cups

**Milk Cup Capacity:** Up to 0.6L

**Water Tank Capacity:** 2.0±5%L

**Coffee Bean Container Capacity:** 250±5%g

**Machine Pre-heating time:** <50s

**2.4G Wi-Fi frequency range:** 2412-2472 MHz

**Supported Connections:** WLAN IEEE 802.11 b/g/n wireless

**2.4G Wi-Fi maximum RF output power:** 20 dBm

**RF exposure information:** 2.4G Wi-Fi maximum

## 2 Your Fully Automatic Espresso Machine

Beverage Quantity Table				
Beverage	Default Coffee Quantity	Program-mable Quantity	Default Milk Quantity	Program-mable Milk Quantity
Espresso	30 ml	25 - 45 ml	N.A.	N.A.
Doppio	30 ml + 30 ml	50 - 90 ml	N.A.	N.A.
Ristretto	20 ml	10 - 30 ml	N.A.	N.A.
Lungo	60 ml	50 - 90 ml	N.A.	N.A.
Americano	140 ml	80 - 160 ml	N.A.	N.A.
Espresso Macchiato	30 ml	25 - 45 ml	10 ml	10 - 50 ml
Flat White	60 ml	50 - 90 ml	60 ml	40 - 80 ml
Cortado	60 ml	50 - 90 ml	60 ml	40 - 80 ml
Caffe Latte	60 ml	50 - 90 ml	190 ml	160 - 200 ml
Ristretto Bianco	40 ml	20 - 60 ml	110 ml	90 - 130 ml
Cappuccino	30 ml	25 - 45 ml	150 ml	130 - 170 ml
Latte Macchiato	30 ml	25 - 45 ml	220 ml	200 - 240 ml
Travel Mug	280 ml	200 - 320 ml	N.A.	N.A.
Iced Americano	30 ml + U.I.	25 - 45 ml	N.A.	N.A.
Iced Latte	30 ml	25 - 45 ml	U.I.	U.I.
Cold Brew	160 ml	x1 OR x2	N.A.	N.A.

\*N.A. Not Applicable

\*U.I. User Input

## 3 Preparation - Installation

### 3.1 Installation

**i**

- Remove any protective films, stickers and any other packaging material from the appliance.
- If you spot any coffee traces in the grinder, they're the outcome of tests done to set up the appliance before selling it.
- When you use the appliance for the first time, it's important to rinse all the parts that touch water or milk - like the milk carafe, drip tray, and water tank - with hot water. For cleaning the milk carafes, using a dishwasher is our suggested method.

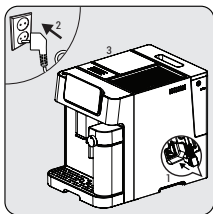

Connect the appliance to the mains supply. Press the flag corresponding to the desired language and confirm the selection by pressing "Done".

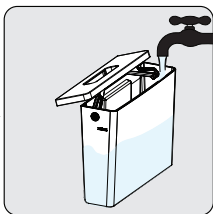

Remove the water tank and fill to the MAX line with fresh water then put the tank back.

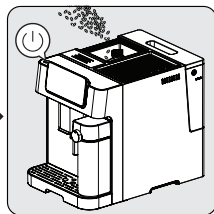

Fill the beans container. Press the on/off button to turn on the machine.

**i**

To prevent water overflowing from the water tank, do not add water directly into the appliance from another container.

### 3 Preparation - Installation



- Never fill the water tank with warm or hot water, sparkling water or any other liquid that might damage the water tank and the machine.
- When the **Water Empty** pop-up appears, the water tank is at a low water level and requires filling.

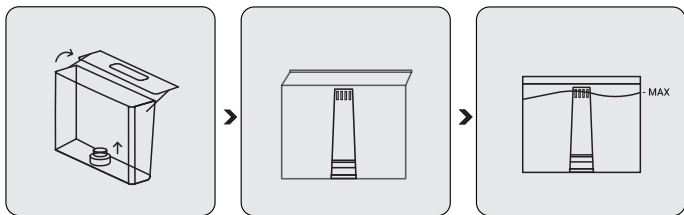

In order to use water filter, Please remove the filter which inserted on water tank and insert water filter instead as shown.

## 4 Operation

### 4.1 Grinding Adjustment

You can adjust the grinding coarseness by turning the adjustment knob on the bean container.

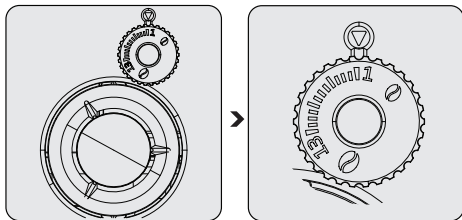

Never do the grinding adjustment when the grinder is not operating. It may damage the grinder.



The lines on the adjustment knob indicate the coarseness of the grind. Bigger number means coarser grind level.

### 4.2 Filling the bean containers



- When the **Bean Container Empty** pop-up appears, the appliance needs to be filled with coffee beans.
- Storing bean in its original vacuum pack is better to ensure longer lasting freshness. Do not use the coffee bean container for storage purposes for better results.

## 4 Operation

### 4.3 Using the pre-ground coffee container

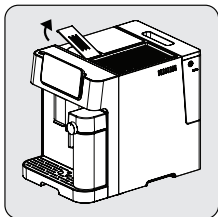

Remove the pre-ground coffee chute lid.

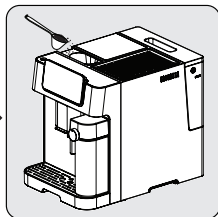

Slowly put the pre-ground coffee in the pre-ground coffee chute.

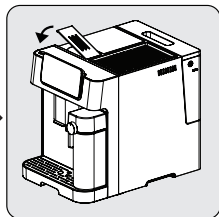

Place the chute lid back on.



Pre-ground coffee chute is not a storage unit, it offers a one-time usage (max 13g). Measurement spoon accessory can be used for suggested amount of ground coffee.



- To use pre-ground coffee, scroll down the "Coffee Strength" bar to the lowest level until ☞ icon activated.
- Store your espresso grounds in an airtight container, and in a cool, dry place to retain the flavor. Grounds should not be kept for long periods of time as the flavor will be reduced.
- Espresso level ground coffee should be used.

## 4 Operation

### 4.4 Using the Cup Holder

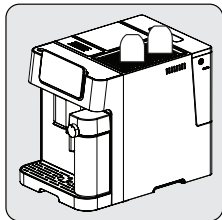

Cups should be placed upside down to ensure internal surface is kept warm and clean (This function uses the internal heat of the machine and works in consecutive usage of the device).

## 4 Operation

### 4.5 Preparing Your Coffee

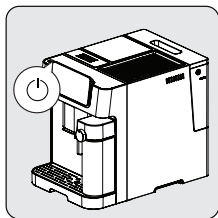

Switch on the appliance by pressing the power on/off button. The appliance turns on, starts pre-heating and auto-cleaning. It is ready for use in idle mode in which all icons are lit.



Place a cup under the coffee spout and adjust the height of the spout according to the cup.

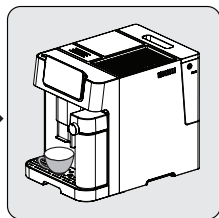

Select your coffee by pressing button and the cup lighter will turn on indicating that the appliance is preparing a cup of coffee. When the appliance returns to idle, the coffee is ready to serve.

## 4 Operation

### 4.5.1 Preparing Coffee with Milk

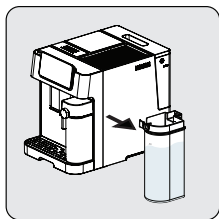

Hold the milk cup with one hand. Remove the cover of the milk cup. Add milk to the milk cup. The milk amount should not exceed the max level. The recommended temperature for milk is 4-8 °C (~40-46 °F). Close the cover of milk cup.

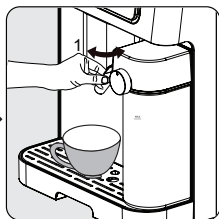

Attach the milk cup to the appliance, it must click audibly into place. Make sure that the milk cup fits correctly. Adjust the angle of the milk cup nozzle over the cup. Adjust the milk foam density with the help of milk foam adjustment knob based on your preferences.

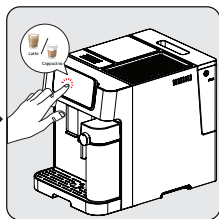

Select your desired milk coffee from the screen and the cup lighter will turn on indicating that the appliance is preparing a cup of coffee. When the appliance returns to idle, the coffee is ready to serve.

**i**

- To ensure your espresso stays at optimum temperature, we recommend that you preheat your cups.
- In addition to the coffee used, using fresh cold water that is free of chlorine, odors and other impurities will help ensure the perfect espresso.

**i**

This machine allows the user to set the foam ratio by turning the knob from Max to Min to enjoy the desired foam. Suggested setting can be viewed by pressing the (i) button on the screen.

## 4 Operation

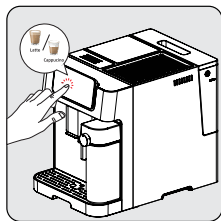

Press the button of preferred coffee. Then one beep sound will be heard. The selected beverage's button will start blinky and brewing will start.



The pump will work intermittently as the milk froth first enters your cup. After the milk froth is ready, the device automatically starts to brew the coffee.



When the unit beeps once, the beverages is ready enjoy!  
- The machine will revert to idle mode.



Always make sure the milk cup is placed correctly. If not fitted well; the milk beverages will not be available. Buzzer will sound as 3 beeps to indicate this.



The removal of the milk cup has no impact on the black coffee presets, they can still be used.

## 4 Operation

### 4.6 Cancelling

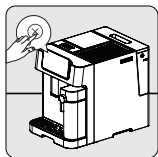

Press  to cancel.



Pressing the on/off button 2 times will force-shut down the device.

## 5 Cleaning

### 5.1 Cleaning the appliance

1. Disconnect the power cord from the mains supply outlet.
2. Pour away all the water/coffee residual inside the drip tray and coffee residual container.
3. Use a damp cloth or non-scratching cleaning agent to clean the liquid stains on the appliance.



Never use any abrasive, vinegar or descaling agents not included in the box to clean the appliance.

Timely cleaning and maintenance of the appliance is highly important in prolonging its life.

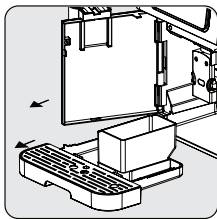

Open the front cover. Remove the drip tray and the coffee residual container.

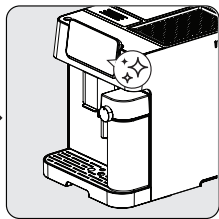

Press the ✨ icon and click on the text to initiate the 'Milk Cup Cleaning' function from the screen.

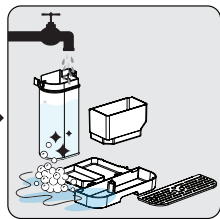

Empty the coffee residual container, the drip tray. Wash coffee residual container, drip tray and milk cup with warm running water and use the needle or the bristles of the brush if needed in any parts to clean. Dry them afterwards.

## 5 Cleaning



When the  symbol appears on the screen, please follow the on-screen instructions. This error will occur on the screen after every 10 coffee brews.

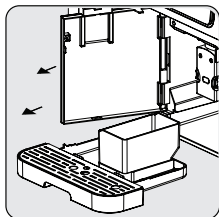

Hold the adjustable coffee spout and pull back slowly to open the front cover.

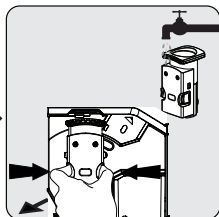

Remove the brewing unit. Wash with water and dry afterwards.

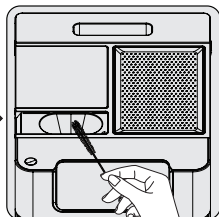

Clean the coffee outlet line with brush.

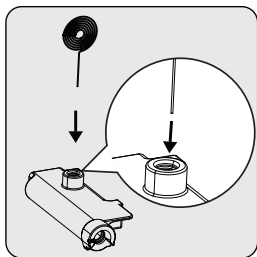

Use the cleaning needle (18) to clean inside the milk frother inlet.

## 5 Cleaning



- The drip tray should be emptied when the floating indicator is visible.
- Powder coffee funnel should be cleaned after each use with the cleaning brush.

### 5.2 Cleaning Functions

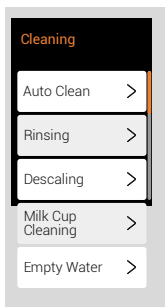

When you press on " ✨ ", you can easily access 5 different cleaning functions: Auto-Cleaning, Rinsing, Descaling, Milk Cup Cleaning, Empty Water, all visible on your screen.

#### 5.2.1 Auto Clean Function

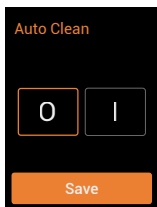

Your appliance cleans itself automatically before and after each brewing operation. To deactivate the automatic cleaning function, switch to the " O " icon on the screen.

## 5 Cleaning

**i** We recommend that you use the auto-clean mode actively for healthy use.

### To cancel auto-clean for once;

Press on/off button while machine is turning on or off to bypass this function.

#### 5.2.2 Rinsing Function

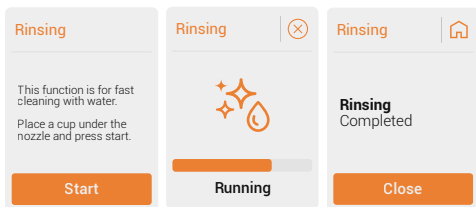

**i** This function is for fast cleaning with water. Follow the steps from the screen.



- The water that comes out of the coffee nozzle is hot and is collected in the drip tray underneath. Avoid contact as it splashes around.
- If the appliance has not been used for a long period of time, this function is suggested to be used.

**i** Using this function before coffee preparation will also ensure hotter coffee.

# 5 Cleaning

## 5.2.3 Descaling Function

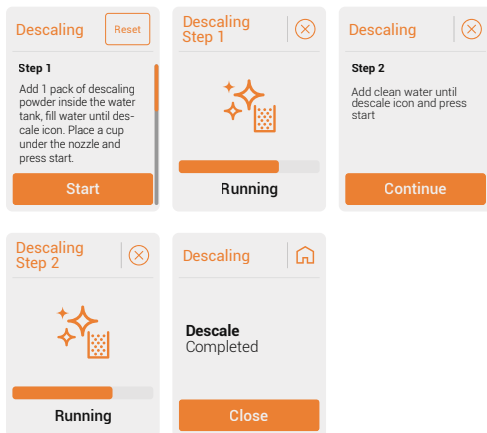

It is recommended to do descaling to maintain the best condition of the device. Follow the steps from the screen.



- Descale is required after predefined brewing cycle.
- Do not use vinegar or other cleaning agents for the self-cleaning of this appliance. Other cleaning agents may damage the appliance.
- Keep the skin/body away from hot water.



Resetting descaling warning status is not suggested for maintaining the best condition of the appliance.

## 5 Cleaning

### 5.2.4 Milk Cup Cleaning

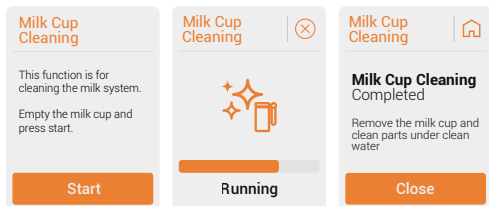





This function is for cleaning the milk cup. Follow the steps from the screen.



This function should be used after every milk related operation.

## 5 Cleaning

### 5.2.5 Empty Water

<p>Empty Water</p> <p><b>Step 1</b> This function is for removing all water inside the device. Place a cup under the nozzle and press start.</p> <p>Start</p>	<p>Empty Water </p> <p><b>Step 2</b> Remove the water tank. Once water tank is removed, function will start automatically.</p>	<p>Empty Water </p> <p></p> <p>Running</p>	<p>Empty Water </p> <p><b>Empty Water Completed</b></p> <p>Close</p>
---	---	--	---



This function is for removing all water inside the device. Follow the steps from the screen.



When the appliance is reused again for the first time after empty system function is used; press the milk button until water comes out of the spout.

## 6 Control Panel Setting

### 6.1 Profile Function

#### 6.1.1 Profile Selection

You can use this function to save beverage settings and favorites for each profile separately. (Orange-Violet-Blue-Green & Guest)



Device will boot into guest profile at first use.



Profile names can be adjusted from the mobile app. Check APP UM for details.

#### 6.1.2 Profile Settings

Device will remember last profile selected, and will select this on next boot. (including guest)

Each profile has a different color to differentiate.



To reset the beverages settings or profiles settings press "Reset".

### 6.2 Mode Selection

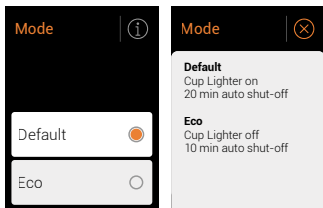

## 6 Control Panel Setting



When Eco Mode is selected. Mode selection LED  will be turned to green.

### 6.3 Beverage Settings

#### 6.3.1 Add Favorite & Remove Favorite

To favorite a beverage press “” icon.

To remove a beverage from your favorites, press “” icon.



You can favorite up to four beverages.

#### 6.3.2 Beverage Customization

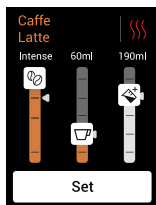

To customize a beverage - Coffee strength, brewing temperature, water & milk volumes- press “” icon.

## 6 Control Panel Setting

### 6.3.3 Add Extra

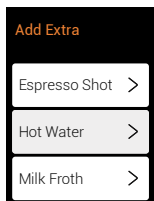

Press "☰" icon.

#### Espresso Shot

To add standard espresso shot to your beverage press "Espresso Shot" on the screen. Follow the steps from the screen.

#### Water Dispensing

To dispense hot water, press "Hot Water" on the screen.

#### Milk Frothing

To add milk, press "Milk Froth" on the screen. After that function we suggest milk cup cleaning.



Please refer to section 5.2.4 Milk Cup Cleaning.

## 7 User Settings

You can access these features by clicking on the “⚙️” icon located in the top right corner of the homepage.

### Language

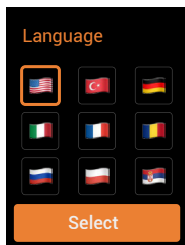

To change the language, go to Settings > Language and select the flag of the relevant language.

### Sound

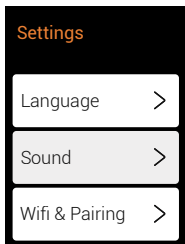

## 7 User Settings

### Wi-Fi & Pairing

#### WIFI & Pairing



Download **Home Direct**  
and start setting up  
pairing

Start

To download the HomeDirect scan the QR code and follow the required steps. (Please see the app guide.)

### Auto Shut-Off

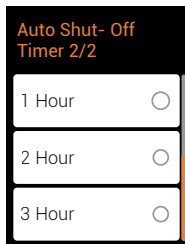
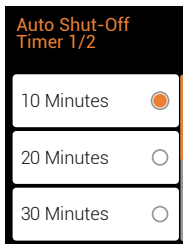

Select the desired time interval (10 or 20 or 30 minutes, 1, 2 or 3 hours).

## 7 User Settings

### Water Hardness

Press “**i**” icon the follow the steps.

#### Step 1

Immerse the measurement strip inside a cup of water planned to be used in the device.



#### Step 2

Wait until the the color changes.



#### Step 3

The number of color changing squares will indicate the water hardness.



### Water Filter Insert



When it is time to change the water filter, the quality of the water can be maintained by installing a mechanical dust filter.

Press “Water Filter Insert” on the screen and follow the steps.

#### Step 1

Unpack the water filter and shake lightly.



#### Step 2

Immerse the water filter upside down into a cup filled with clean water.



#### Step 3

Wait 10 minutes until no more bubbles come out.



## 7 User Settings

### Step 4

Take out the water tank, then remove the mechanical filter inside by pulling it upwards.



### Step 5

Then insert and push the water filter cartridge downwards into the bottom socket until it can not move forward.



### Step 6

Fill the water tank with clean water until MAX level. Place the water tank back onto the device.

Press proceed to start rinsing.



Proceed

## Pre-Brewing Setting

### Pre-Brewing

0

1

Save

The pre-brewing function moistens the coffee inside the brewing unit with a small amount of water before full extraction. This expands the coffee grounds to build up greater pressure in the brewer, which helps extract all the oils and bring out the full flavour of the beans.

## 7 User Settings

### Product Counter

"CaffeExperto V3" has Product Counter feature. It keeps track of how many coffees you've made since you got the machine. This helps you see how much you're using it.

### Software update

This product has remote software update functionality for potential new additions. You can always look for new software versions from the settings menu. Check for updates in the relevant section, if available, you will be redirected to the "update" section.

**i** Please follow the steps in the "HomeDirect, Audio Control and Software Update" guide.

**i** Make sure your phone is connected to the device and you have a stable connection during the update. Do not turn off the device while the update process is in progress.

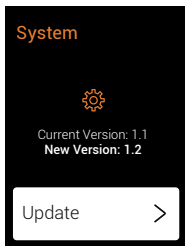
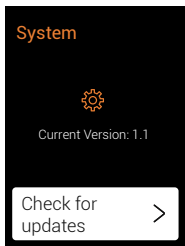





## 8 Troubleshooting

Problem	Cause	Solution
The appliance does not work.	The appliance is not connected to the mains.	Plug in and press the switch. Check the cable and the plug.
No or delayed response in several attempts of pressing a function key on the panel	Appliance is under electromagnetic interference. The panel is dirty.	Unplug the appliance. Restart after a few minutes. Clean the panel with the cloth provided.
The coffee is not hot enough.	The cups have not been preheated. The brewing unit is too cold.	Place your cup on the cup warmer facing down or rinse the cup with hot water. Make sure that the water in the water tank is not too cold.
Coffee is not coming out of the coffee spout.	The empty system function may have been used previously. The coffee spout may not have been cleaned and is blocked by coffee residues.	Press the cleaning button until water comes out of the spout. Clean the coffee spout.
The first cup of coffee is of poor quality.	The first running of the grinder does not place a sufficient quantity of coffee into the brewing unit.	Throw the coffee away. The next cups will be better.
The water tank is removed / the water level is very low in the water tank but there is no "💧" alert.	The area near the water tank connector could be wet.	Wipe off the water around the water tank connector.

## 8 Troubleshooting

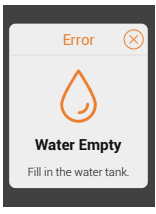
Problem	Cause	Solution
The internal drip tray is filled with a lot of water.	The ground coffee is too fine, which blocks the water from coming out.	Adjust the coffee fineness to larger grains for the grinding process.
Coffee is delivered too slowly or a drop at a time.	Coffee grounds are too fine, which blocks the water from coming out.	Adjust the coffee fineness to larger grains for the grinding process.
The indicator flashes to inform that there's not enough coffee beans, but there are plenty inside the container.	The internal coffee grounds outlet is blocked.	Follow the steps described for cleaning the coffee grounds outlet.
The brewer or the coffee ground tray is impossible to remove.	The appliance did not finish the self-cleaning process and was switched off .	Please switch on the machine again and let it finish its auto cleaning process.
The appliance no longer performs the rinsing cycle when switched on or off.	Improper handling when servicing the appliance may be the cause.	<ol style="list-style-type: none"><li>1. When the appliance is in idle condition, open the front cover.</li><li>2. Press and hold the on/off button until you hear 2 beeps.</li><li>3. Close the front cover.</li></ol>
The touch buttons are not sensitive.	Not pressing the touch button from the front of the appliance.	Press the lower bottom part of the symbol of the touch button from the front of the appliance.

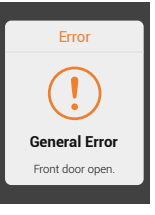
## 9 Pop-up

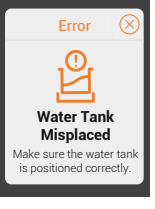
 <p><b>Error</b> (X)</p>  <p><b>Water Empty</b></p> <p>Fill in the water tank.</p>	<p>Before filling the tank, please verify that it is fully inserted. Once confirmed, proceed with filling the tank.</p>	 <p><b>Warning</b> (X)</p>  <p><b>Descal</b></p> <p>It is suggested to descale the device.</p>	<p>Descaling program recommended. Follow on-screen instructions. Ignoring this pop-up may compromise appliance condition.</p>
 <p><b>Error</b> (X)</p>  <p><b>No Coffee</b></p> <p>Fill bean container or use ground coffee option.</p>	<p>Select the correct coffee type (beans or ground) on the screen, then fill the container or chute as preferred.</p>	 <p><b>Error</b></p>  <p><b>General Error</b></p> <p>Front door open.</p>	<p>Front door open. Please ensure it is closed securely.</p>
 <p><b>Error</b></p>  <p><b>Residual Full</b></p> <p>Empty the coffee residual container.</p>	<p>After several cups of beverage consumption, a pop-up notification appears. Please empty the residual container.</p>	 <p><b>Error</b></p>  <p><b>General Error</b></p> <p>Brewing unit misplaced. Place the components in its place.</p>	<p>Brewing unit displaced. Reinsert brewing unit into its place.</p>
 <p><b>Error</b> (X)</p>  <p><b>Milk Cup Missing</b></p> <p>Place the components in its place.</p>	<p>Missing milk cup during beverage preparation triggers a pop-up. Replace milk cup.</p>	 <p><b>Error</b> (X)</p>  <p><b>Water Tank Misplaced</b></p> <p>Make sure the water tank is positioned correctly.</p>	<p>Make sure the water tank is positioned correctly.</p>

## Product Guarantee

### 12 months breakdown and repair guarantee

Guarantor: **Beko plc, 1 Greenhill Crescent, Watford, Hertfordshire. WD18 8UF**

The guarantee does not in any way diminish your statutory or legal rights.

Your **appliance** has the benefit of our manufacturer's guarantee which covers the product for 12 months from the date of original purchase.

This gives you reassurance that if within that time, your **appliance** is proven to be defective because of either workmanship or materials, we will at our discretion either repair or replace your **appliance**.

The **appliance** must be correctly installed, located and operated in accordance with the instructions contained in the user manual. The guarantor disclaims any liability for accidental or consequential damage.

#### The Guarantee is subject to the following conditions:

- Documentary proof of the original purchase date is provided.
- The appliance has been installed and operated correctly and in accordance with our operating and maintenance instructions.
- The appliance is used only on the electricity supply on the rating plate.
- The appliance has only been used for normal domestic purposes.
- The appliance has not been altered, serviced, dismantled or otherwise interfered with by any person.
- The appliance is used in the United Kingdom or Republic of Ireland.
- Any parts removed during repair work or any product that has been replaced becomes our property.
- The guarantee is not transferrable if the product is resold.

#### The Guarantee does not cover:

- Transit, installation or delivery damage.
- Accidental damage.
- Misuse or abuse.
- Replacement of any consumable item or accessories. These include but are not limited to: plugs, cables, light bulbs, knobs, filters and flaps.
- Repairs or replacements required as a result of unauthorised repairs or inexpert installation that fails to meet the requirements contained in the user guide or instruction book.
- Repairs to products used in commercial or non-residential household premises.

#### How to obtain after sales service, help or general advice

**Please keep your purchase receipt or other proof of purchase in a safe place as you will need to show us this document if your product requires attention within the guarantee period.**

Please also record your product details below, which will allow you to access our services more quickly and help us identify your product. The model number is printed on the front of the user guide and the serial and model number is shown on your products rating plate.

Model number	Serial number	Purchased from	Date of purchase

Please call our UK based Customer Service department if you need help or advice from us:

United Kingdom and Northern Ireland: **0333 207 9710**

Republic of Ireland: **01 862 3411**

You can also contact us through our website: **www.beko.co.uk**